

INDEXABLE BORING BAR AND INSERTS

1/4" CARBIDE SHANK - DIAMOND SHAPED INSERTS

EACH BAR COMES WITH ONE SCREW AND ONE KEY. INSERTS SOLD SEPARATELY.

BAR WITH COOLANT HOLE

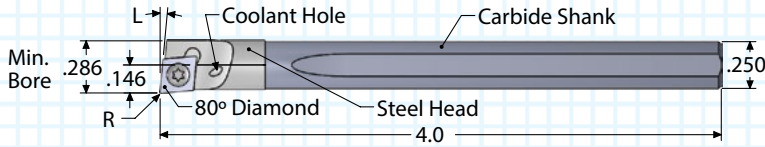

"L" ANGLE	BAR FLAT	INSERT TYPE	RH/LH	ORDER #
				COOLANT THROUGH
5°	NONE	ACD5	RIGHT	ADBC250R5R
5°	FLAT	ACD5	RIGHT	ADBC250F5R
0°	NONE	ACD5	RIGHT	ADBC250R0R
0°	FLAT	ACD5	RIGHT	ADBC250F0R
5°	NONE	ACD5	LEFT	ADBC250R5L
5°	FLAT	ACD5	LEFT	ADBC250F5L
0°	NONE	ACD5	LEFT	ADBC250R0L
0°	FLAT	ACD5	LEFT	ADBC250F0L

CARBIDE INSERTS

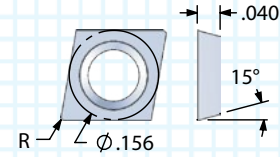

80° DIAMOND FLAT TOP

FIVE SCREWS	"R" CORNER RADIUS	ORDER NUMBER	
		FIVE UNCOATED	FIVE ALTiN+
AT6+	0.003	ACD5031	ACD5031E
AT6+	0.007	ACD5071	ACD5071E
AT6+	0.015	ACD5151	ACD5151E

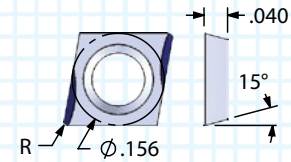

80° DIAMOND CHIP CONTROL
RIGHT HAND ONLY

FIVE SCREWS	"R" CORNER RADIUS	ORDER NUMBER	
		FIVE UNCOATED	FIVE ALTiN+
AT6+	0.007	ACD507L2	ACD507L2E
AT6+	0.015	ACD515L2	ACD515L2E

BAR WITHOUT COOLANT HOLE

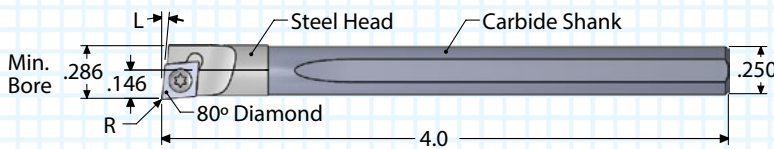

"L" ANGLE	BAR FLAT	INSERT TYPE	RH/LH	ORDER #
				NO COOLANT HOLE
5°	NONE	ACD5	RIGHT	ACBC250R5R
5°	FLAT	ACD5	RIGHT	ACBC250F5R
0°	NONE	ACD5	RIGHT	ACBC250R0R
0°	FLAT	ACD5	RIGHT	ACBC250F0R
5°	NONE	ACD5	LEFT	ACBC250R5L
5°	FLAT	ACD5	LEFT	ACBC250F5L
0°	NONE	ACD5	LEFT	ACBC250R0L
0°	FLAT	ACD5	LEFT	ACBC250F0L

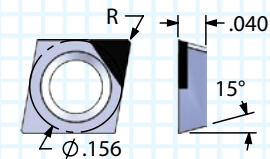

80° DIAMOND CBN/PCD TIPPED

ONE SCREW	"R" CORNER RADIUS	ORDER NUMBER	
		ONE CBN	ONE PCD
AT6+	0.007	ACD5071CBN2	ACD5071PCD
AT6+	0.015	ACD5151CBN2	ACD5151PCD

INDEXABLE BORING BAR FEED AND SPEED CHART

MATERIAL	HB/Rc	SPEED RANGE (SFM)		CUTTING CONDITIONS		
		UNCOATED	ALTIN+	MAX DOC ACD & ATD	MAX DOC ATP & ACP	FEED IPR
CAST IRON	160 HB	75-200	200-550	0.020	0.060	.0005-.010
CARBON STEEL	18 Rc	75-200	200-450	0.018	0.060	.0005-.010
ALLOY STEEL	20 Rc	75-200	200-425	0.015	0.060	.0005-.010
TOOL STEEL	25 Rc	75-175	175-300	0.010	0.030	.0005-.010
300 STAINLESS STEEL	150 HB	75-175	175-350	0.015	0.028	.0005-.010
400 STAINLESS STEEL	195 HB	75-210	130-420	0.012	0.028	.0005-.010
HIGH TEMP ALLOY (Ni & Co BASE)	20 Rc	50-130	130-300	0.008	0.020	.0005-.010
TITANIUM	25 Rc	50-120	120-275	0.009	0.022	.0005-.010
HEAT TREATED ALLOYS (38-45Rc)	40 Rc	50-100	100-200	0.005	0.010	.0005-.005
ALUMINUM	100 HB	75-250	250-750	0.025	0.095	.0005-.010
BRASS, ZINC	80 HB	75-300	250-650	0.023	0.090	.0005-.010

SFM = Surface Feet per Minute

Starting parameters only. Length to diameter ratios, setup, and machine rigidity may affect performance. The max Depth Of Cut (DOC) acceptable at the minimum Inches Per Revolution (IPR).

SELECTING AN INDEXABLE BORING BAR

1	From the part or print, verify the diameter of hole to be machined. Select the boring bar that has a minimum bore diameter smaller than the diameter to be machined.
2	Check machine for shank size needed. If the shank needs to be larger, go to page 96.
3	Match the operation needed on the part with the necessary lead angle. Select 0° lead to bore to a shoulder. Select 5° lead to bore and face a shoulder.
4	Choose from flat top or chip control insert based on application and material being machined.
5	Choose from .003", .007", or .015" radius based on finish required and part specifications for corner radius.

SELECTING AN INDEXABLE INSERT GRADE

UNCOATED	is a submicron premium carbide grade for machining steel and non-ferrous materials.
ALTIN+	is a premium coated grade for steel, cast irons and high temperature alloys at highest SFM.
CBN	are ideal for hardened steel (45+ RC) and cast iron.
PCD	are ideal for non-ferrous materials.

INDEXABLE BORING BAR TROUBLESHOOTING

PROBLEM	CAUSE	SOLUTION
RAPID FLANK WEAR	CUTTING CONDITIONS	Reduce the cutting speed.
	INSERT	Select a coated grade.
	HEAT	Use the SCT coolant holder. If coolant is not available, use shop air and a coated tool. Use a coolant through boring bar.
BUILT-UP EDGE	INSERT	Select a coated grade.
	CUTTING FORCE	Use chip control insert to free up cut.
	HEAT	Use coolant through boring bar or holder. If coolant is not available, use shop air and a coated tool. Use coolant through boring bar.
INSERT BREAKAGE	CUTTING CONDITIONS	Reduce depth of cut. Reduce feed rate.
	INSERT	Select a larger corner radius
	PART	Check the drilled hole to make sure the full diameter of the drill is deeper than the programmed bore depth.
SURFACE TOO ROUGH	CUTTING CONDITIONS	Reduce feed rate. The rate is too great for the nose radius.
	INSERT	Select a larger corner radius. The feed rate (IPR) should not be greater than 1/2 the nose radius.
CHATTER	SETUP	Set insert above center. Change the speed of the machine. The overhang ratio should be less than 8x bar diameter for carbide. Clamping length should be at least 3x the boring bar diameter.
	BORING BAR	Select the largest diameter bar that will bore the required diameter.
TAPER BIGGER IN BACK	CUTTING FORCES	Forces may deflect bar below center causing the hole to become larger.
	BUILT-UP EDGE	A built-up edge will cause the hole to become large until the built-up edge breaks off, then hole will be smaller.
	PROGRAM	If the taper is consistent (not from chip packing) then the program can be altered to bore a taper in opposite direction resulting in a straight hole.
TAPER SMALLER IN BACK	CHIP PACKING	If the boring bar is too large to allow chips to evacuate then the chips may pack on the insert and cause the bar to deflect away from the bore.
	PROGRAM	If the taper is consistent (not from chip packing) then the program can be altered to bore a taper in opposite direction resulting in a straight hole.

INDEXABLE BORING BAR DEFLECTION

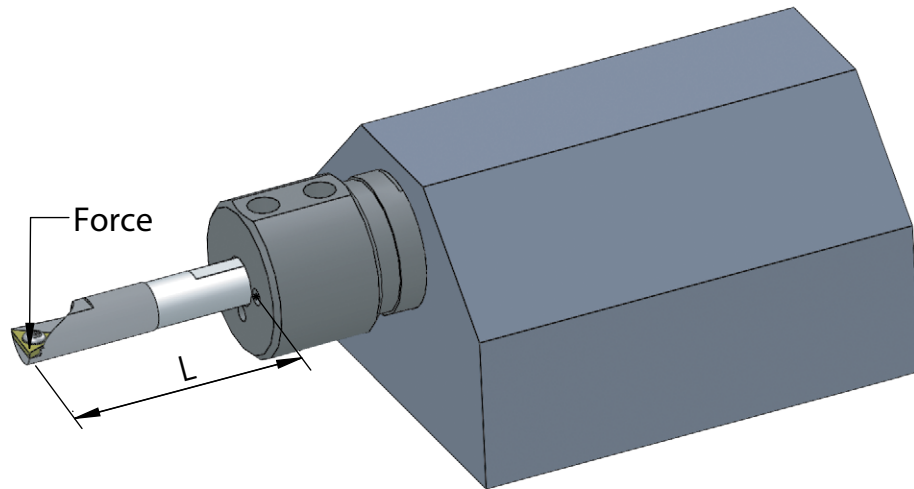

Bar Deflection:
$$\frac{F \times L^3}{3 \times E \times I} \quad I = \frac{3.14 \times D^4}{64}$$

F = Cutting force (lbs) L = Overhang (in.) E = Coefficient of Elasticity of Bar Shank D = Tool Diameter I = Moment of Inertia

The greatest amount of force on the boring bar is on the top of the cutting edge. This force can deflect the cutting edge below the centerline of the part, resulting in incorrect bore size.

To minimize deflection, the length of overhang should be kept as short as possible. As shown in the formula, the length of overhang is multiplied to the third power, and the diameter is multiplied to the fourth power. This means that a small change in length of overhang or bar diameter can make a large difference in deflection.

Using the largest diameter bar with the least amount of overhang as possible gives the best chance of successful boring operations.

The picture shows the boring bar in a coolant holder.* Coolant or shop air provided to the holder will cool the insert and part and evacuate chips from the hole.

*Coolant holders available. See page 46.